



# МЕБЛЕВА ФУРНІТУРА

фасадні ручки ● тримачі для полиць  
фурнітура для ванної ● опорні системи





**REI**

**993**

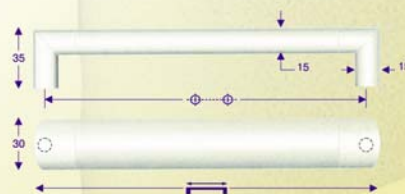

**991**

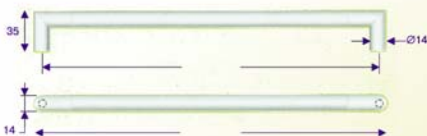
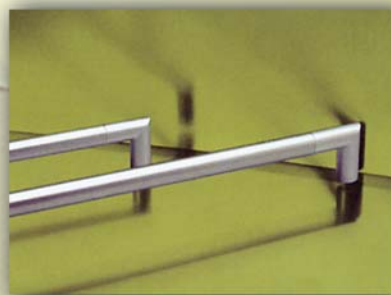

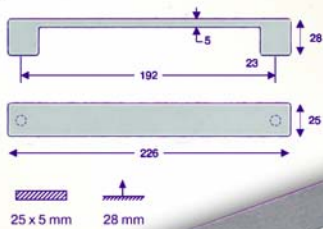

# 585

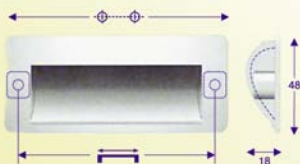
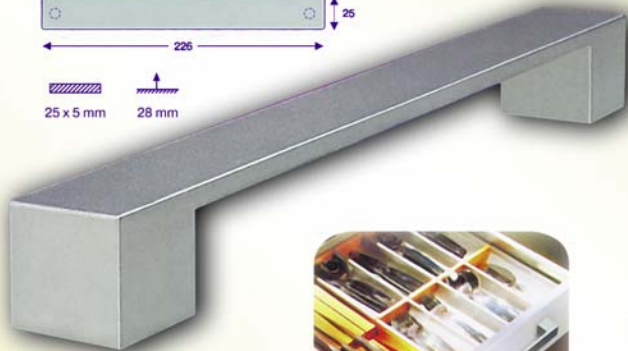

# 583



96 110  
128 142



# 193

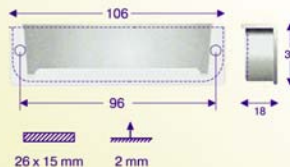

# 558

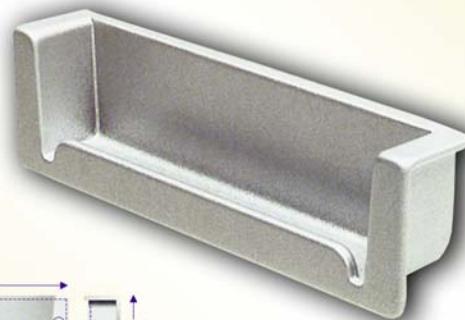
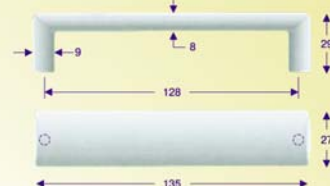

**Стандартне покриття:**

**Ma** Анодований алюміній

2285

ANM I MA CM I MC

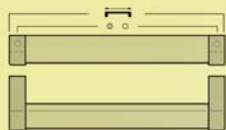

22 x 11 mm	38 mm
128	140
160	172
192	204



Pi-029

Pack 2 u.

CM I MC



CT-230

ANM I MA

22 x 11 mm	1000
------------	------



2288

ANM I MA



12 x 9 mm	30 mm
128	138
160	170
192	202
224	234
320	330
448	458

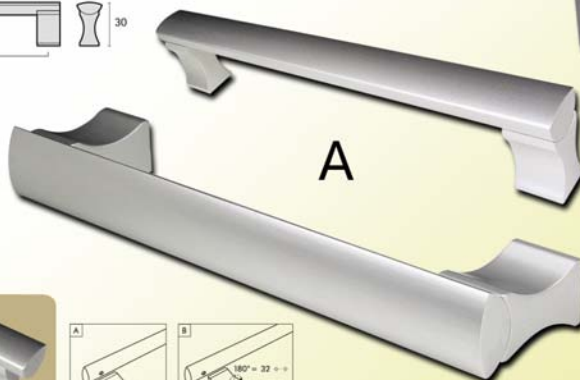

2289

MA

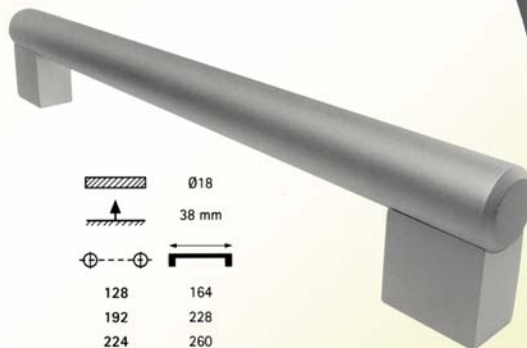
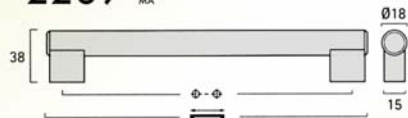

Ø18	
38 mm	
128	164
192	228
224	260
320	356
448	484
632	668

2286

ANM I MA CM I MC

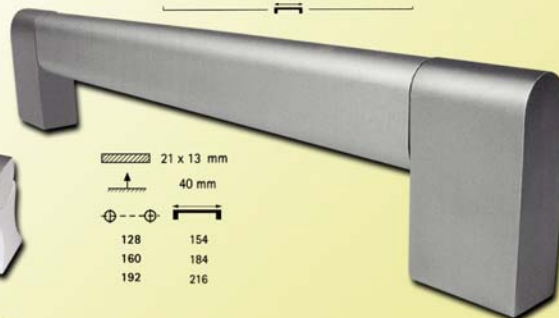

21 x 13 mm	40 mm
128	154
160	184
192	216

Pi-034

Pack 2 u.

ANM I MA

CT-231

CM I MC

21 x 13 mm	1000
------------	------

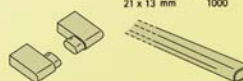

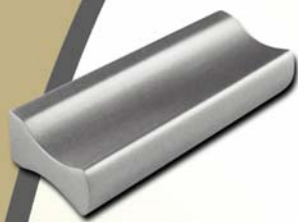

2279

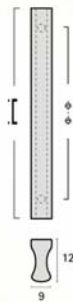

12 x 9 mm	12 mm
32	44
64	88
96	120
128	150
160	190



2275

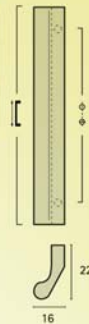

22 x 7 mm	22 mm
32	44
64	88
96	120
128	150
160	190
224	270
320	367
448	497

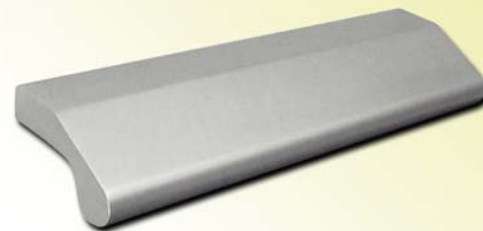

2274

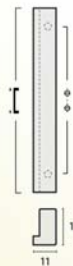

18 x 11 mm	18 mm
32	44
64	88
96	120
128	150
160	190



2265



21 x 7 mm	30 mm
128	135
160	167



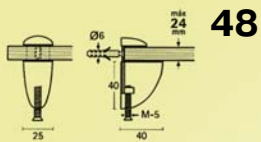

48

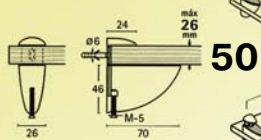

50

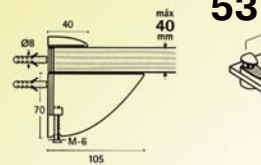

53



48



67

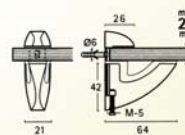

67

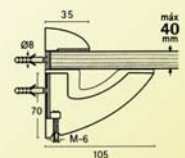

68



68

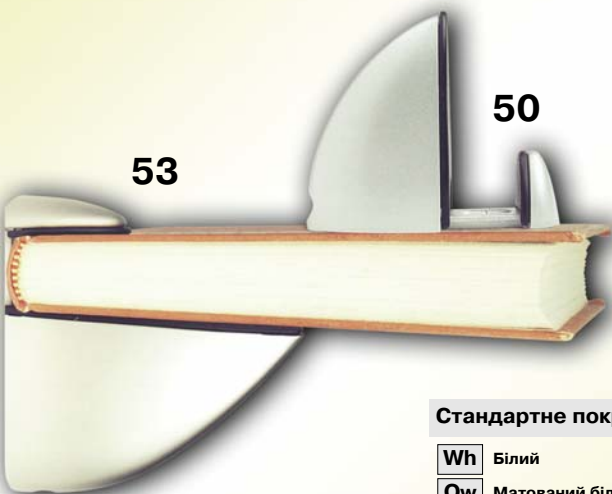

50

53

**Стандартне покриття:**

<b>Wh</b>	Білий
<b>Ow</b>	Матований білий
<b>Bk</b>	Чорний
<b>Ob</b>	Матований чорний
<b>Bw</b>	Коричневий
<b>Msc</b>	Матований хром
<b>Mnc</b>	Матований нікель
<b>Bn</b>	Нікель "bisu"
<b>Pc</b>	Полірований хром
<b>Pg</b>	Поліроване золото
<b>Gf</b>	Сіра ковка



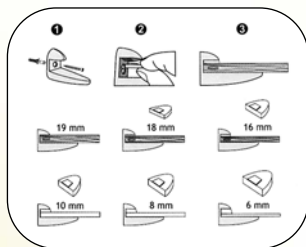

46

46

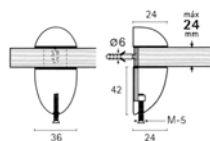

47

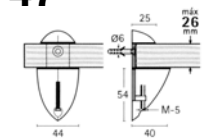

51

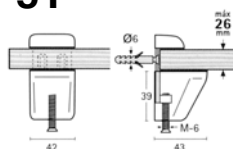

51



47

**Стандартне покриття:**

<b>Wh</b>	Білий
<b>Ow</b>	Матований білий
<b>Bk</b>	Чорний
<b>Ob</b>	Матований чорний
<b>Bw</b>	Коричневий
<b>Msc</b>	Матований хром
<b>Mnc</b>	Матований нікель

<b>Mn</b>	Матований нікель
<b>Bn</b>	Нікель "bisu"
<b>Pc</b>	Полірований хром
<b>Pg</b>	Поліроване золото
<b>Gf</b>	Сіра ковка

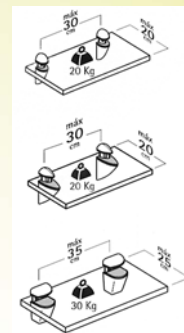

64

64

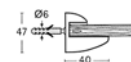

65

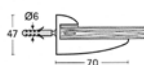

65

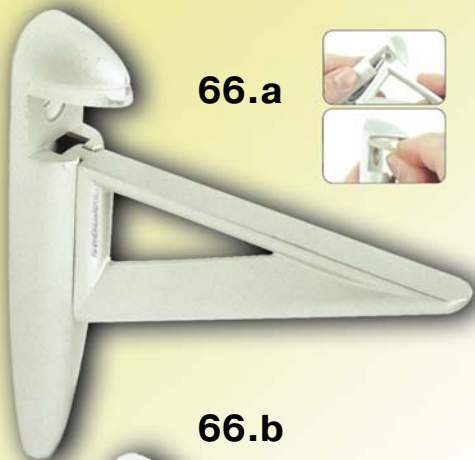

66.a

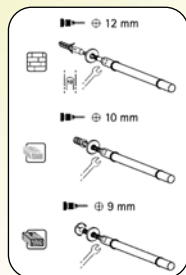

49.150

49.200

49.250

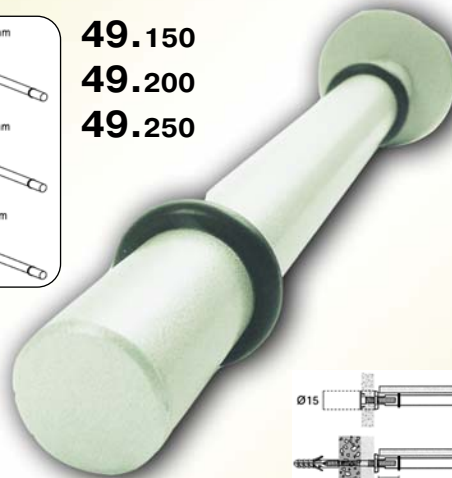

66.b



66.a

66.b

66.c

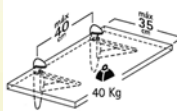
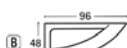
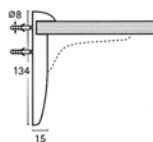

66.c

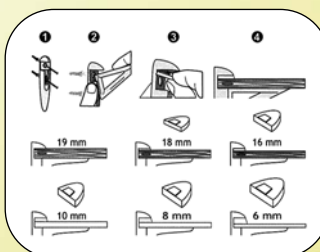

Стандартне покриття:

- Ow** Матований білий
- Ob** Матований чорний
- Mcc** Матований хром
- Mnc** Матований нікель
- Pc** Полірований хром
- Gf** Сіра ковка





**86/87.к**



1 5 6

**86/87.M4T**



1 3 4 7

**86/87.M4B**

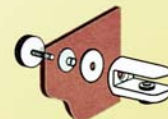

2 3 4

**86/87.M4D**

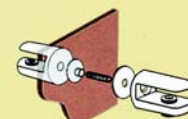

3 4 8

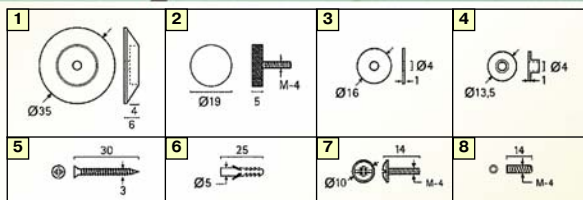

**86**

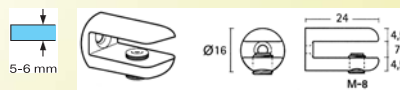

**87**



**86/87.05**



**Стандартне покриття:**

- Wh** Білий
- Mcc** Матований хром
- Pc** Полірований хром
- Pg** Поліроване золото

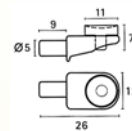
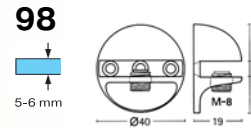
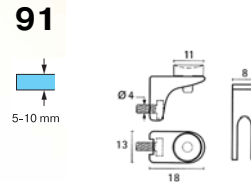
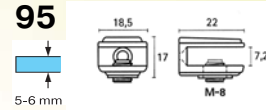
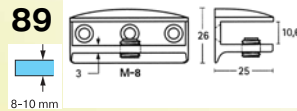
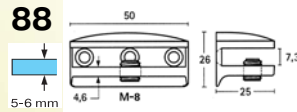
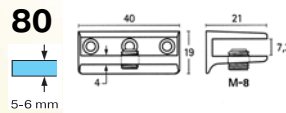
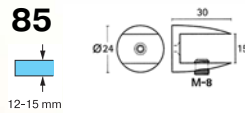

**Стандартне покриття:**

<b>Wh</b>	Білий
<b>Мсс</b>	Матований хром
<b>Рс</b>	Полірований хром
<b>Рg</b>	Поліроване золото
<b>Pb</b>	Полірована латунь
<b>Ni</b>	Нікель
<b>Tr</b>	Прозорій





630

635

636

600

633

605

633

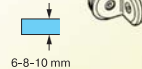

635

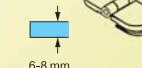

636

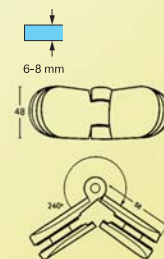

600

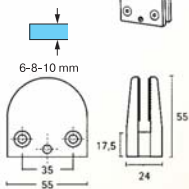

605

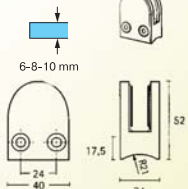

630

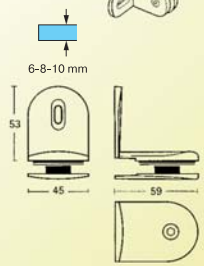

**Стандартне покриття:**

<b>Wh</b>	Білий	<b>Mc</b>	Матований хром
<b>Mcc</b>	Матований хром	<b>INOX</b>	Неіржавеюча сталь
<b>Pc</b>	Полірований хром		

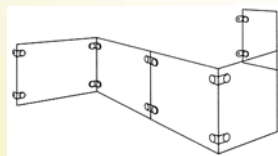
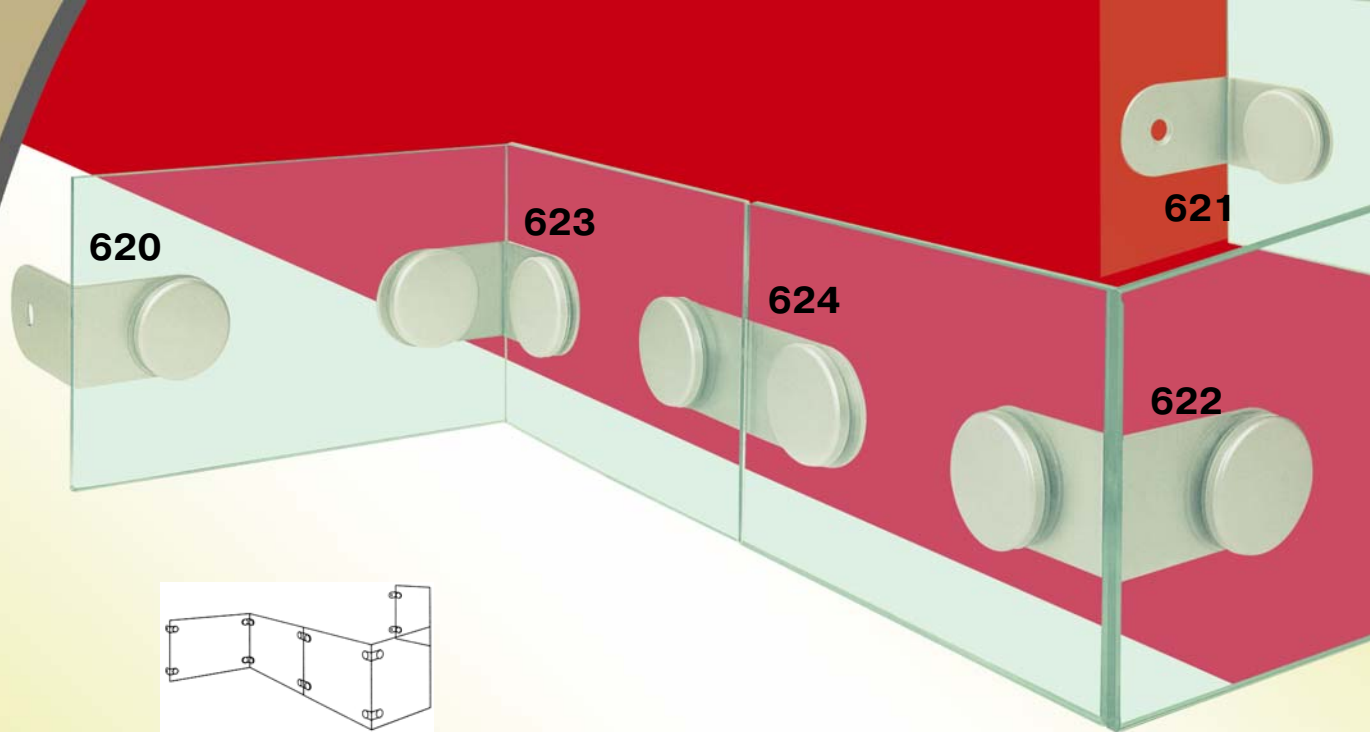

**620**

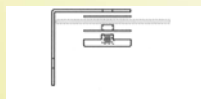

**621**

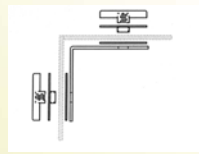

**622**



**623**

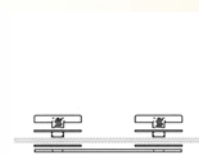

**624**

**Стандартне покриття:**

- Мсс** Матований хром
- Рс** Полірований хром

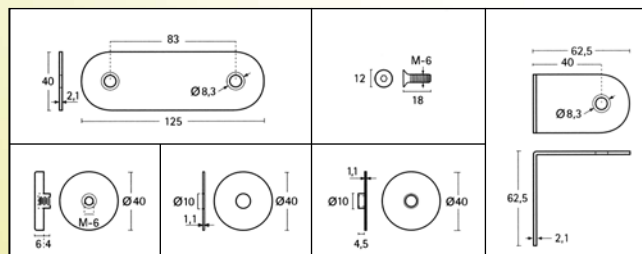

### Полірована кришка



- 12mm
- 14mm
- 16mm
- 18mm

AU NI PG NI  
L B

**112**  
**114**  
**116**  
**118**

### Різна кришка

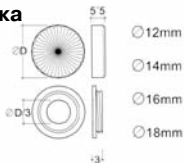

- 12mm
- 14mm
- 16mm
- 18mm

AU NI PG NI  
L B

**122**  
**124**  
**126**  
**128**

### Тримач для дзеркала

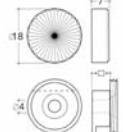

- 2-5 mm
- 5-9 mm

**130**  
**131**  
AU NI PG NI  
L B

### Дюбель

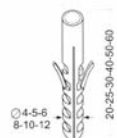

- 4x20 mm
- 5x20 mm
- 6x30 mm
- 8x40 mm
- 10x50 mm
- 12x60 mm

**70**

**117**

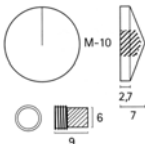

**62**

WH  
GR  
BK  
MH  
OK  
Pi  
BK  
PP

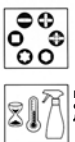
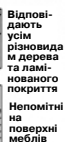
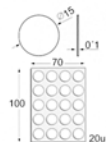

Відповідають усім різновидам дерева та ламінованого покриття



Непомітні на поверхні меблів

Волого-стійкі та довговічні

**63.12**

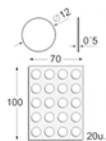

Посадка на всі стандартні отвори

○ 10-12mm

WH / LW / GR / BK / LB / CR / BCH / LO / OK / Pi / WL / CH / PB / MH PVC



Відповідають усім різновидам дерева та ламінованого покриття

Непомітні на поверхні меблів

Волого-стійкі та довговічні

Відповідають усім типам гвинтів

**63.17**

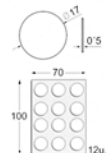

Посадка на всі стандартні отвори

○ 15-16mm



### Стандартне покриття:

<b>Pg</b>	Поліроване золото
<b>Ni</b>	Нікель
<b>B</b>	Латунь
<b>Wh</b>	Білий
<b>Lw</b>	Молочно-білий
<b>Gr</b>	Сірий

<b>Bk</b>	Чорний
<b>Lb</b>	Матований чорний
<b>Cr</b>	Кремовий
<b>Bch</b>	Бук
<b>Lo</b>	Світлий дуб
<b>Ok</b>	Дуб

<b>Pi</b>	Сосна
<b>Wl</b>	Горіх
<b>Ch</b>	Вишня
<b>Pb</b>	Клен
<b>Mh</b>	Махогон
<b>Pp</b>	Бумага
<b>Pvc</b>	PVX





**3302**



**3301**

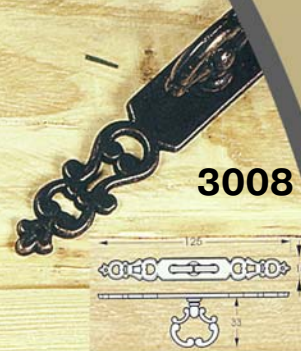

**3008**

**Стандартне покриття:**

- Ab** Антична латунь
- Ac** Антична мідь
- Pw** Олово
- Bf** Чорна ковка



**3007**



**3009**



**3412**

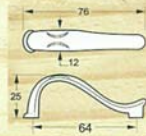

**3412**



**2000**



**3110**



**3111**



**3109**



**3307**



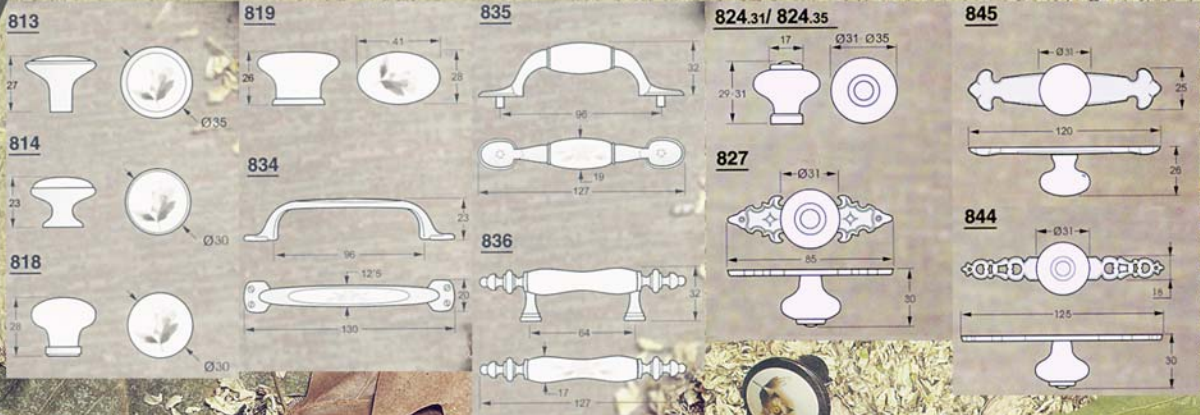



**2004**

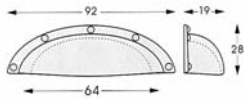

**3000**

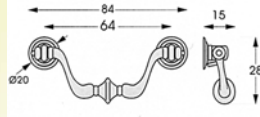

**3001**

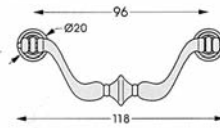

**3002**

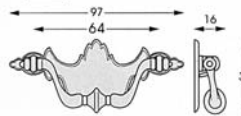

**3003**

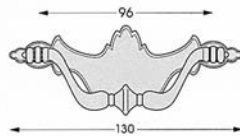

**3014**

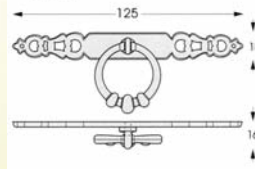

**3009**

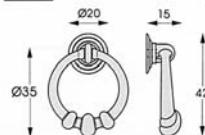

**3401**

**3402**

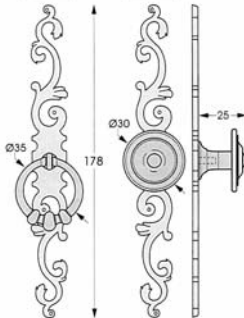

**PL-3**  
с/В



- Всі позиції цієї сторінки:**
- виготовлено з цинкового сплаву zamak
  - колір покриття - антична латунь
  - укомплектовані кріпленнями М4
  - мають індивідуальну упаковку



**3100**

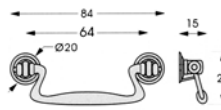

**3101**

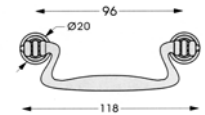

**3102**

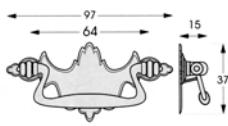

**3103**

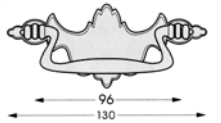

**3108**

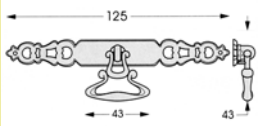

**3105**

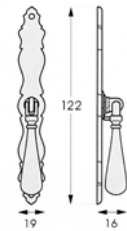

**3106**

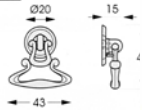

**3109**



**3110**

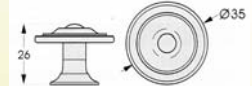

**3201**

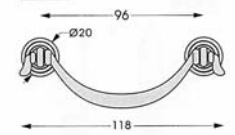

**3200**

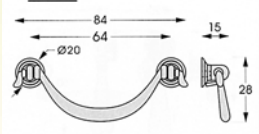

**3204**

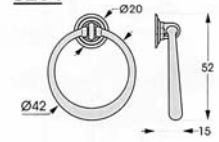

**3205**

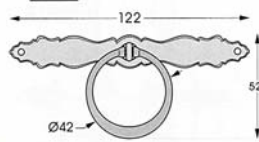

**3202**

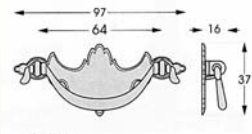

**3203**

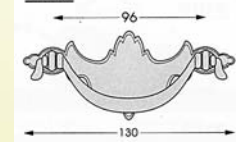

**3104**

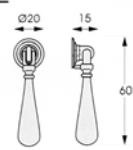

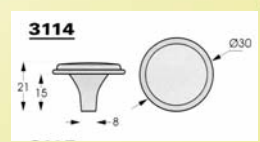
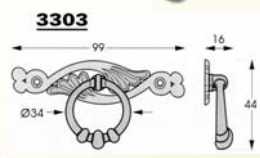
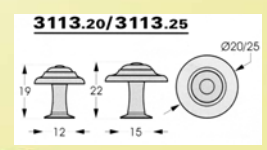
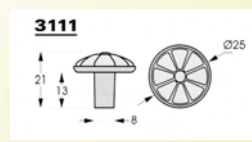
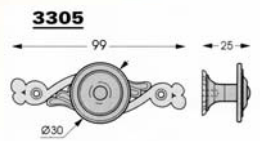
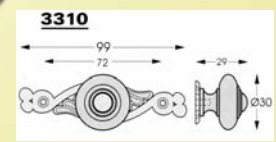
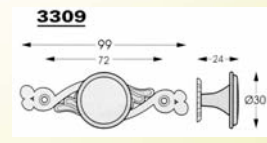
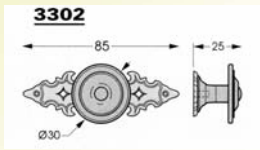
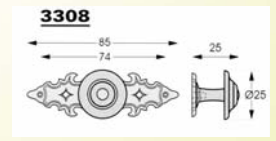
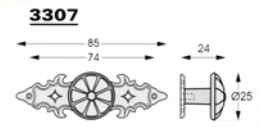
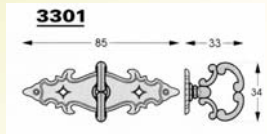
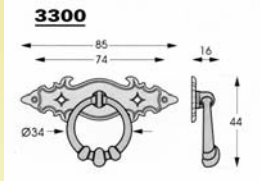



**2000**

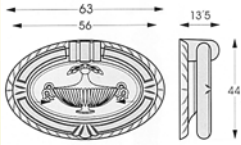

**2002**

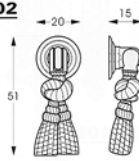

**1087**

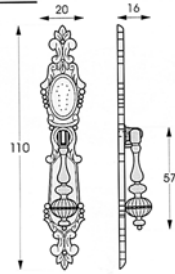

**2008.38/2008.46**

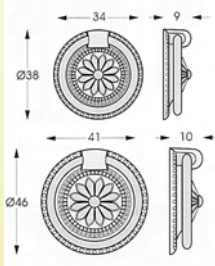

**1101**

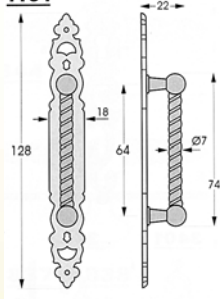

**1088/1089**

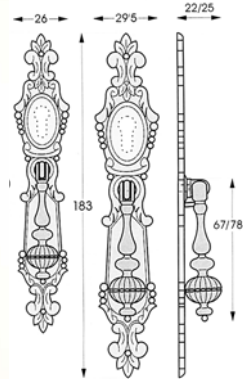

**2006**

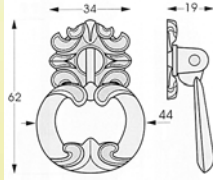

**1093**

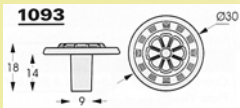

**1090**

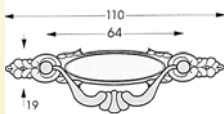

**1097**

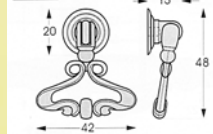

**1091**

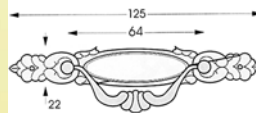

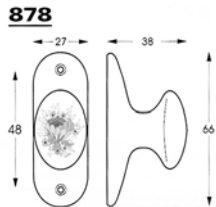
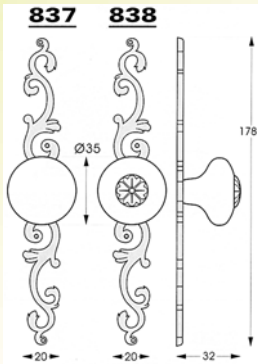

**823**

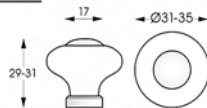

**824**

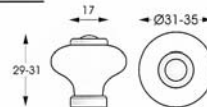

**888**

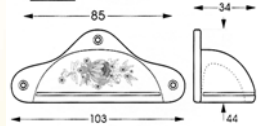

**844**

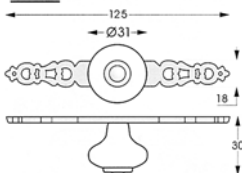

**827**

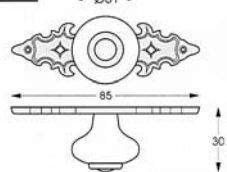

**825**

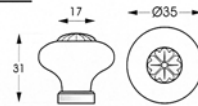

**839**

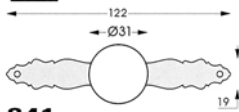

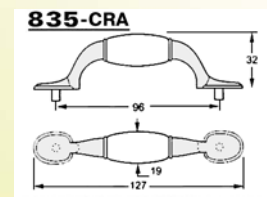
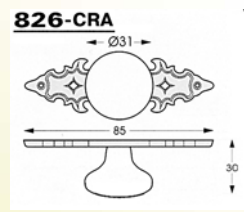
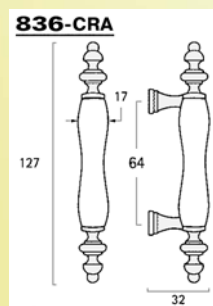
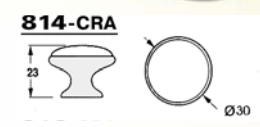
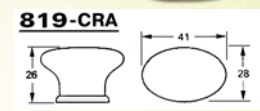
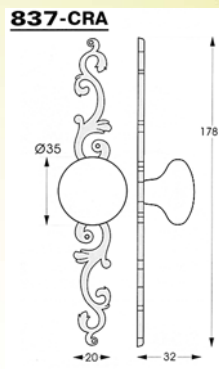
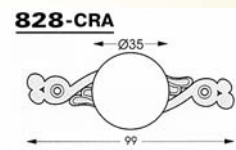
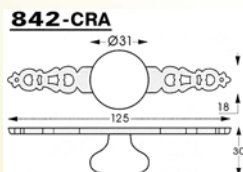

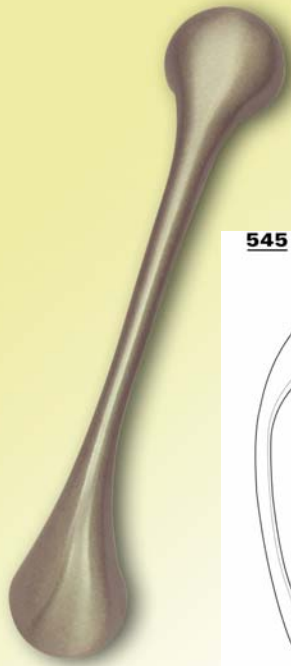

**545**

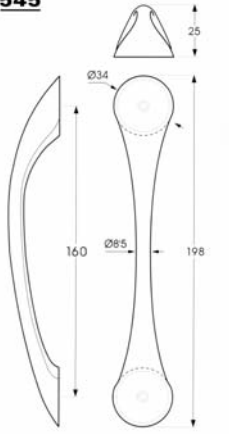

**745**

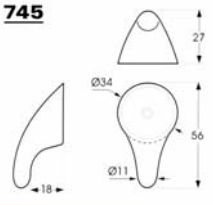

**744**

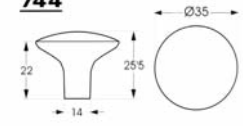

**756**

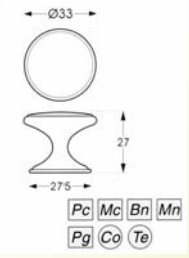

**566/567**

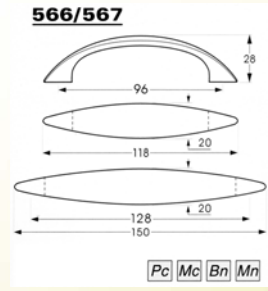

**764**

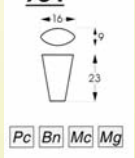

**588.128**  
**588.160**

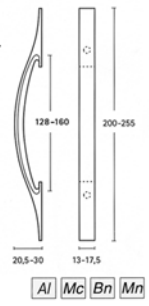

**Стандартне покриття:**

- Pc** Полірований хром
- Mc** Матований хром
- Bn** Нікель "bisu"
- Mn** Матований нікель "сатін"
- Pg** Поліроване золото
- BB** Бронза
- Gt** Графіт
- Ob** Матований білий
- Ob** Матований чорний



**587**

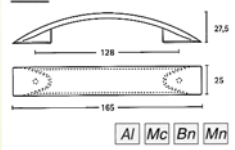

**593**

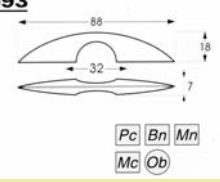

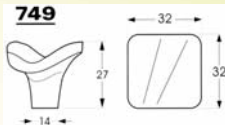
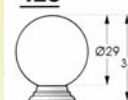
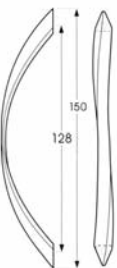
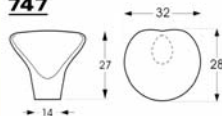
**762****749****425****543****747**

Pc	Mc	Bn	Mn
----	----	----	----

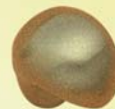
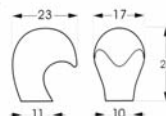
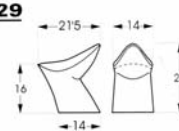
**728****729****Стандартне покриття:**

- Pc** Полірований хром
- Mc** Матований хром
- Bn** Нікель "бісу"
- Mn** Матований нікель "сатін"
- Pg** Поліроване золото
- Ab** Антична латунь
- Gt** Графіт
- Pb** Полірована латунь

- |           |           |           |
|-----------|-----------|-----------|
| <b>Wh</b> | <b>Gr</b> | <b>Bk</b> |
| Білий     | Сірий     | Чорний    |

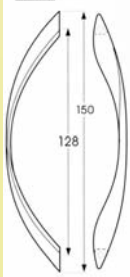
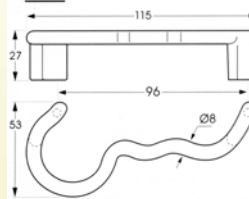
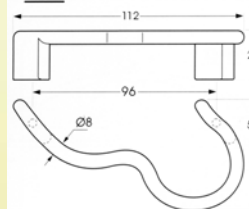
**549****598****599**

Pc	Mc	Bn	Mn
----	----	----	----

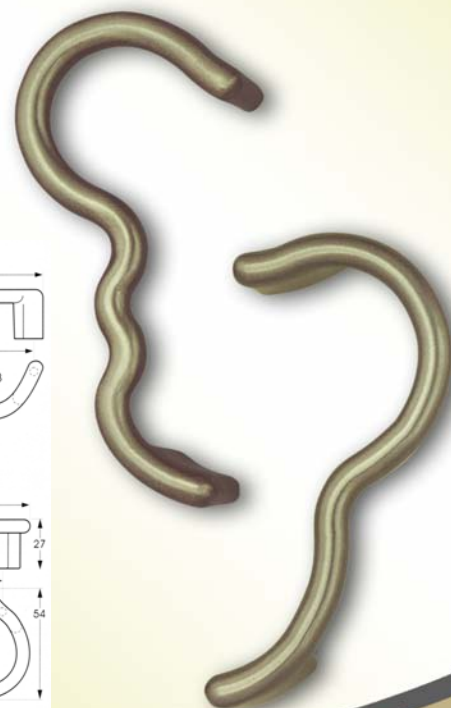

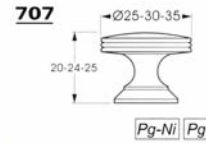

**Стандартне покриття:**

- Pc** Полірований хром
- BB** Бронза
- Gt** Графіт
- Pg** Поліроване золото
- Vn** Нікель "bisu"
- Mc** Матований хром
- Pb** Полірована латунь

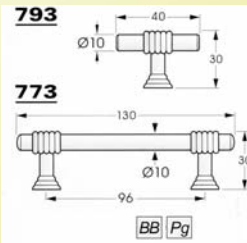
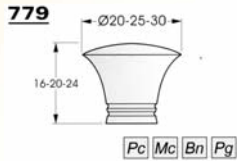
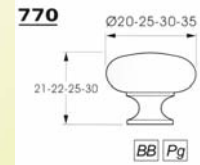
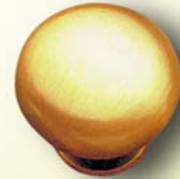



**302/303**

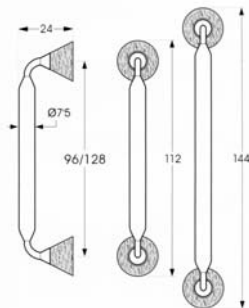

**835-Ro**

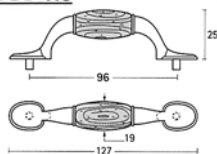

**Всі позиції цієї сторінки:**

- металеві частини вироблено з цинкового сплаву zamak
- металева частина оздоблено різьбою M4 та укомплектована гвинтами M4 для фіксації ручки на меблях



**216**

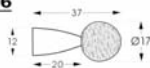

**269**

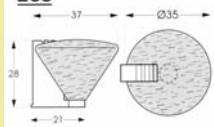

**310**

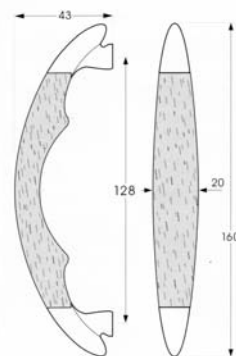

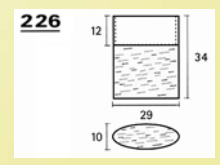
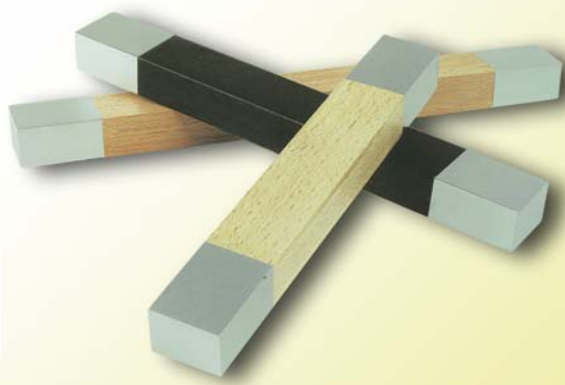
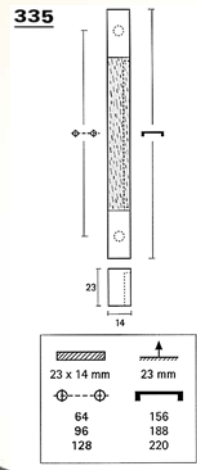
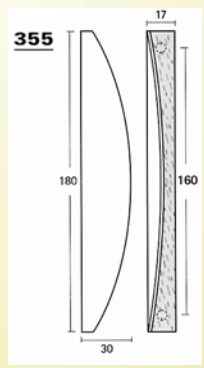
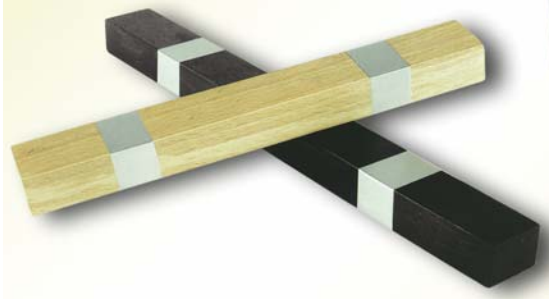
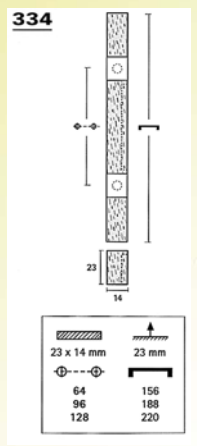
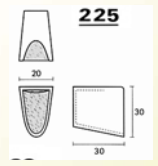
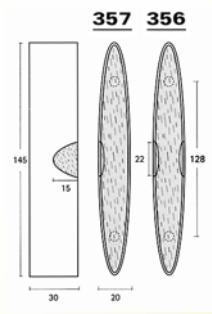
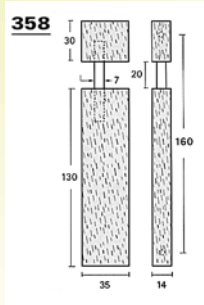

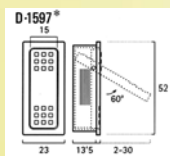
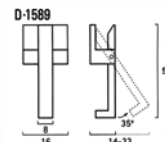
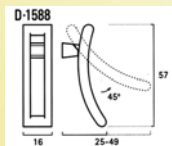
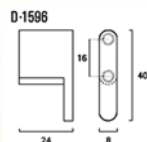
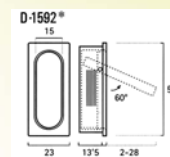
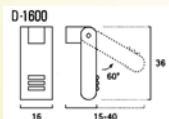
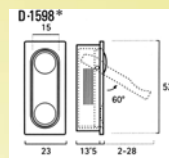
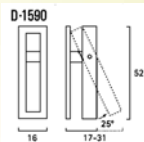
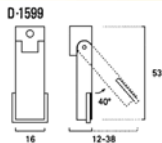

**Всі позиції цієї сторінки:**  
 - металеві частини вироблено з цинкового сплаву zamak  
 - металева частина оздоблено різьбою M4 та укомплектована гвинтами M4 для фіксації ручки на меблях

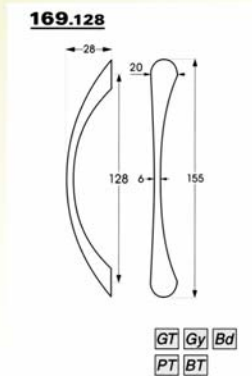
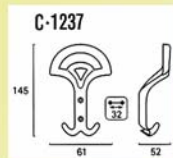

**Стандартне покриття:**

- Gt** Зелений тефлон
- Gy** Сірий тефлон
- Bd** Бургундський тефлон
- Pt** Рожевий тефлон
- Bt** Синій тефлон
- Bn** Нікель "bisu"
- Te** Матований тефлон

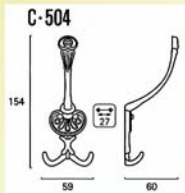

**Стандартне покриття:**

- Bn** Матований нікель "bisu"
- Al** Алюміній
- Pc** Полірований хром
- Bl** Синя пластмаса
- Ve** Велюр
- MT** Матована пластмаса
- BB** Бронза
- Bf** Чорна ковка
- Sg** Срібро
- Ug** Коричнево-сірий металік
- BN** Бук, натуральний лак

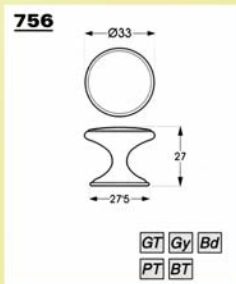
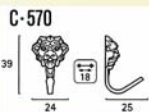
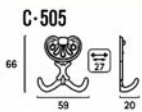

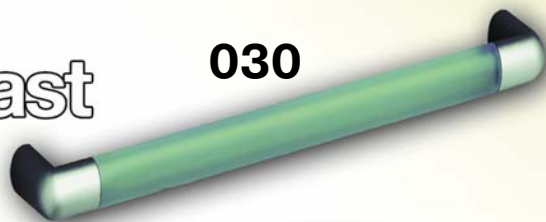

**030**

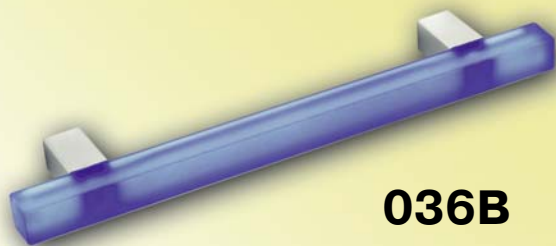

**036B**



**024Q**



**053** Ø35



**054**

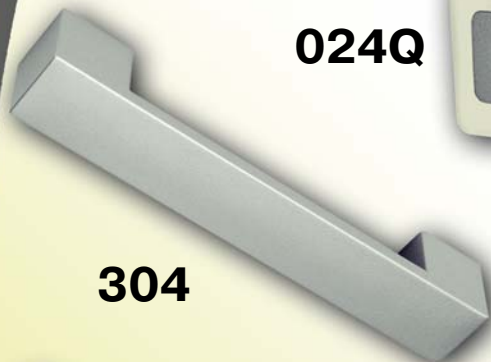

**304**



**057**



**096**



**078B**  
Ø30.5

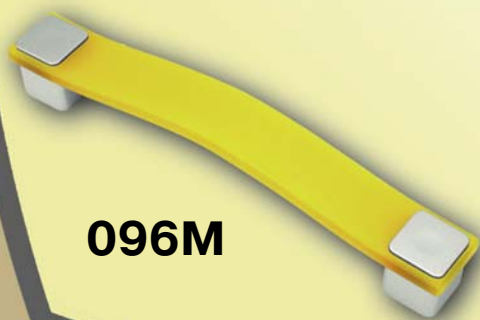

**096M**



**078A**  
Ø24



**069**



**078C**  
Ø35

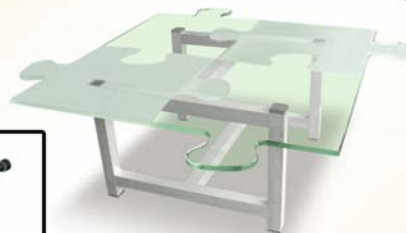

601-A



601-B

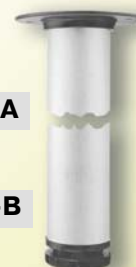

Код	Розмір
200	Ø 40 мм
110	Ø 50 мм
600	Ø 60 мм



Код	Розмір
330	30x30 мм
120	40x40 мм



2010



2011



102



100



101



201



Код	Розмір
100	



125



132 30x30 мм



122 40x40 мм





121 40x40 мм



530 Ø 30 мм



540 Ø 40 мм

	Ø 40мм	Ø 50мм	Ø 60мм	Ø 60мм гафрована	30x30мм	40x40мм
	114	114	114	114	114	114
	202	112	602	602	132	122
	200	110	600	660	330	120
	203	111	603	603	333	121



**BECUSA, S.A.**



**nayes**  
**NE**



*Marta*

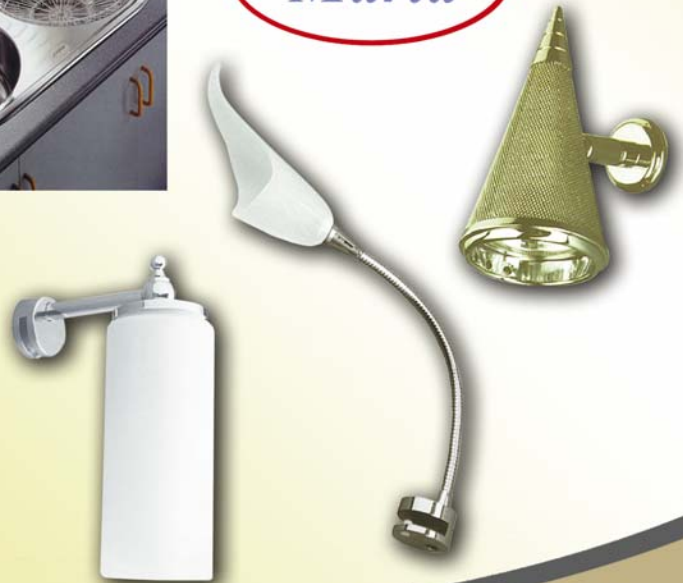



**ШОУ РУМ**

м. Київ, м. Лівобережна  
вул. Марини Раскової, 11, 3 пов.  
тел.: (044) 391-1704, 239-2265  
моб. тел.: 8 050 358-9335

**Дизайн-студія "Скло в інтер'єрі"**

м. Київ, вул. Прорізна, 22  
тел.: (044) 279-50-91, 238-6828

**Склад-Виробництво "Вишневе"**

Київська обл. м. Вишневе,  
вул. Київська, 13А  
тел.: (044) 239-0949, 239-0556



[www.busel.ua](http://www.busel.ua)